



Electricity Operated Advanced Computerized Irrigation Controller Installation and Operating Instructions

FOR AC 4-6-6S-9S-12S

Main Features:

- Operation of 4 to 12 valves plus a master valve (or pump to increase the pressure).
- Operation of 2 valves simultaneously plus a master valve.
- Separate irrigation schedule programmable for each valve.
- Use of 24 VAC electric valves.
- Valve assignment to a lockout sensor.
- Programmable weekly / cyclical irrigation schedules.
- Up to 4 irrigation activations per day per valve in programmable weekly schedule mode
- Irrigation duration: one minute to 12 hours.
- Irrigation duration: one second to 12 hours in AC-6S-9S-12S models.
- Irrigation frequency: once a day to once every thirty days.
- Irrigation frequency: once a minute to once every thirty days in AC-6S-9S-12S models.
- "Manual" operation of individual valves via the irrigation controller.
- Sequential "manual" operation of all the valves via the irrigation controller.
- Identification of short circuits in the system, disconnection of a shorted valve, and a visual indication.
- Operation by means of a 24 VAC -230 VAC transformer (included).
- 9V battery program backup.
- Controller programmable using backup battery power; connection to electrical source not required.
- Irrigation duration variable according to percentage value.

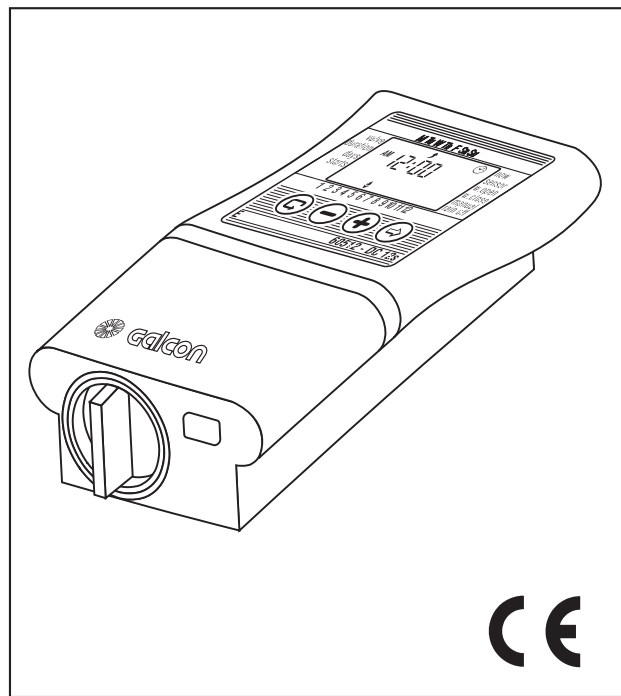

Israel's Leading Manufacturers of Irrigation Controllers

1. Preparations for Operation.....	3
1.1 Installation of the Electric Valves	
1.2 Manual-Mechanical Operation	
2. AC-4-6-6S Installation and Connection	4
2.1 Installation of the Controller in the Irrigation System	
2.2 Backup Battery Installation	
2.3 About the Transmission cable	
2.4 Connecting the Solenoid Wires to the AC Voltage Source and to a Sensor	
3. AC-9S-12S Installation and Connection.....	8
4. Programming the Irrigation Controller	11
4.1 Setting the Current Time and Day of the Week	
4.2 Switching between AM/PM and a 24 Hour Time Format	
4.3 Valve Selection	
4.4 Setting the Irrigation Duration	
4.5 Selecting Days of the Week for Irrigation	
4.6 Setting Irrigation Start Times	
4.7 Example: Programming a Weekly Irrigation Schedule	
5. Additional Functions.....	15
5.1 One-Time Irrigation	
5.2 Cyclical Irrigation	
5.3 Setting the Day of the Week and Time for Cyclical and One-Time Irrigation Programs	
5.4 Irrigation Window In the Cyclical Program Mode	
5.5 Opening an Irrigation Window after the Start Time has passed	
5.6 Example: Programming a Cyclical Irrigation Schedule	
5.7 "Manual" Irrigation System Operation via the Irrigation Controller	
5.8 Sequential "Manual" Operation of all the Valves	
5.9 Suspension	
5.10 Irrigation Duration Extended or Shortened by a Specified Percentage	
6. Additional Displays.....	23
6.1 Valve in Wait Mode	
6.2 Blinking Low Battery Warning	
6.3 Missing Irrigation Program Data	
6.4 AC OFF - no AC Voltage Supply	
6.5 Valve Short Circuit	
6.6 Assigning a Valve to a Sensor	
6.7 Irrigation Lockout Sensor	
7. Maintenance.....	26
8. Troubleshooting and Repair.....	26
9. Additional Accessories.....	27

1. Preparations for Operation

1.1 Installation of the Electric Valves

General

- The irrigation controller is designed to operate standard 24VAC (1.7 W) electric valves (not supplied).
- 1.1.1 Close the master irrigation valve.
- 1.1.2 Assemble the valves in the irrigation system.
Pay attention to the direction of water flow, as indicated by the arrow above the entry pipe (A) (Figure 1).
- A master electric valve can be installed at the head of the irrigation system. The master valve opens automatically when an electrical signal is sent to open one of the valves, and closes automatically when the last valve has closed.
The master valve is denoted by the letter "M" on both the controller display and on the connection block.

1.2 Manual-Mechanical Operation

The irrigation valves can be opened and closed independent of the controller's operation. Manual operation is useful when immediate irrigation is required, and the user does not have enough time or knowledge to program the controller. The valve handle is located under the solenoid,

1. To open the valve, turn the valve handle to the left [2] (Figure 2).
 2. To close the valve, turn the valve handle to the right [1] (Figure 2).
- In electrical operation mode, the manual-mechanical closure is disabled.
 - To operate the valve via the controller, the valve handle must be in closed position [1].

Important!

If there is a master valve, it must also be opened manually.

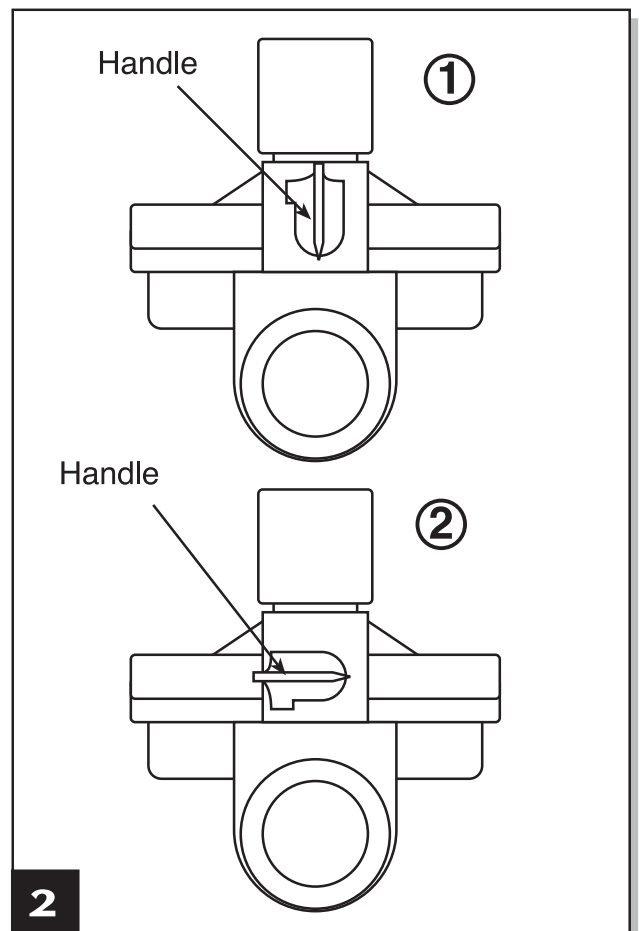
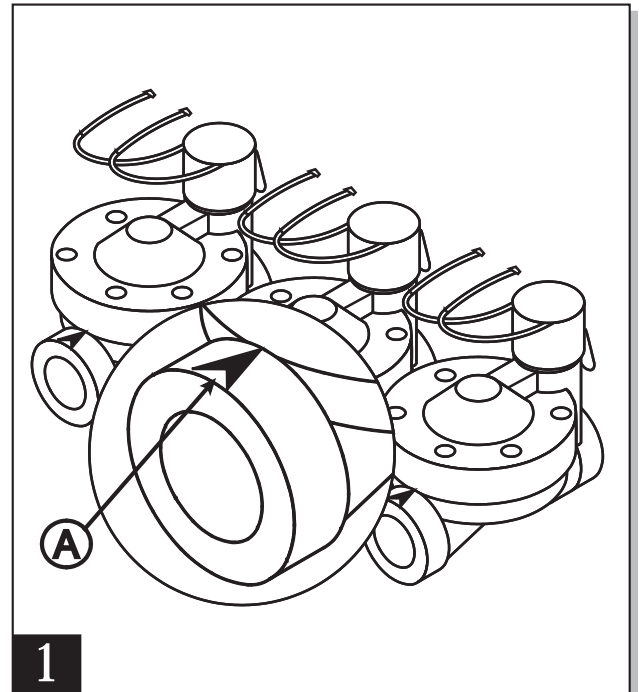

2. AC-4-6-6S Installation and Connection

2.1 Installation of the Controller in the Irrigation System

- The controller is intended for indoor installation, or in a cabinet or other protected, dry location.
 - Connect the controller to an electric outlet dedicated to it alone.
 - Connect the controller to the valves via a transmission cable (not included), as explained below. Install the controller in a location that permits proper cable routing.
1. Remove the mounting plate from the back of the controller. Mount it on the wall or in a cabinet at a convenient height.
 2. Press the controller against the mounting plate and push upwards (see Figure 3).

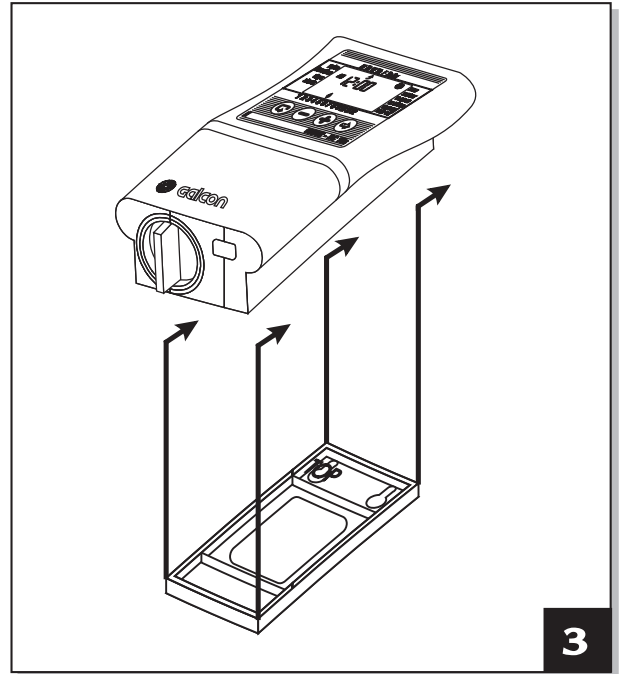

3

2.2 Backup Battery Installation

Open the battery compartment cover. Insert the battery. All the controller displays appear briefly in quick succession, followed by a time of 12:00, which appears as a blinking number. The controller is now ready to be programmed.

Important!

Make sure to replace the battery compartment cover such that the handle is aligned with the left arrow, and then rotate the cover 1/8 of a turn to the right.

- The battery is designed only to back up the programmed irrigation schedules. In the event of a power outage, the battery ensures that the program is not wiped out, but the battery cannot operate the valves.

Alkaline batteries are recommended.

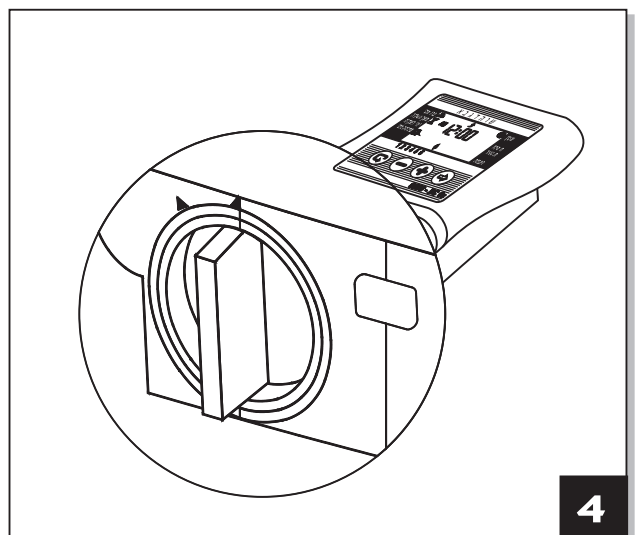

4

2.3 About the Transmission cable

- The transmission cable carries 24VAC only.
- The number of wires in the transmission cable must exceed the number of valves to be operated by at least two: The additional two wires are for the master valve and for the Common wire. The use of color-coded wires is recommended for convenient connection.
- We recommend that you use a cable with spare wires to enable valves to be added at a later date (up to 6), or to replace faulty leads.
- Minimum diameter of the wires in the transmission cable: 0.5 mm. If the valves are located more than 100 meters from the controller, consult the local dealer about the desired wire diameter.
- The transmission cable must be properly routed: if on a wall, using cable clamps; if underground, within suitable protective piping.
- Avoid using multiple segments of cable connected to each other. If such cables must be used, connect the cable ends inside protective connection boxes.
- Transmission cables must be connected to the valves by means of electrical connectors, inside suitably protected connection boxes (not included). Connection boxes should have spare connection points in excess of the number of valves.

2.4 Connecting the Solenoid Wires to the AC Voltage Source and to a Sensor

Connect the valves to the controller before connecting the controller to the mains source. Refer to the explanation and to Figure 5.

WARNING

Use only the transformer supplied, or a CE certified transformer with a 230VAC, 50Hz input, and 24VAC, 830mA output. In addition, it must be a SELV transformer, and IEC 61558 or VDEO 700 compliant.

Connection of the irrigation controller to electrical devices other than the irrigation valves and the transformer must be performed by a qualified electrician only.

General

Each solenoid has two wires of identical color and polarity extending from it. One of the wires (it does not matter which) connects to the matching valve number on the right connection block on the controller (2). The second wire connects to a Common point "C" on the left connection block (3). The distance between the controller and the valves is usually longer than the length of the solenoid's wires, and a "transmission cable" is generally used to connect them (4). The solenoid wires connect up to a connection box (5) installed near the valves. A transmission cable connects the box to the controller. The connection box and transmission cable are not supplied with the product.

Connecting the Solenoid Wires to the Connection Box

1. Mark the connection points in the connection box (5): 1, 2, 3, 4, 5, 6, M and C. We recommend marking all points, even if there are more points than actual valves to be connected.
2. Connect one wire from each solenoid to a separate point in the connection box (5). Ensure that the number of the actual valve matches the number marked in the box: valve 1 to point 1, Valve 2 to point 2, etc. The master valve (if any) connects to the point marked "M" in the box.
3. Connect the remaining wire from each solenoid to the point marked "C" in the connection box.

Connecting the Transmission cable

1. Remove the bottom cover (1) from the controller.
2. Connect the wires from the transmission cable to the connection points on the controller connection block: to points 1-6 on the right connection block (2), and to the "M" and "C" points on the left connection block (3); the "C" connection points are identical. Draw yourself a diagram of the connection point numbers and the colors of the wires that connect to them.
3. Connect the wires at the other end of the transmission cable (4) to the connection box (5) located near the valves, according to the wiring connection diagram prepared in the previous step.

Connecting the Controller to the AC Voltage Source

1. Connect the two transformer wires to the left connection block, at the points marked AC. The polarity does not matter.
2. Connect the transformer to a 230V AC power source. The controller is now ready to execute the programmed irrigation schedules.
3. If a booster pump is required to increase the pressure, it can be activated by connecting a 24V relay to the M point on the controller's left connection block. Do not connect the controller directly to the pump. Connection of the controller to a pump must be performed by a qualified electrician only.
4. Sensor Connection (Optional)
Connect the sensor wires to the point on the left connection block marked SNSR (SN). The polarity does not matter.
5. Note: Do not connect the controller to a power source that is shared with another electrical device.
6. If the controller is connected to a relay of any sort, the controller must be positioned at least 5m from the relay.

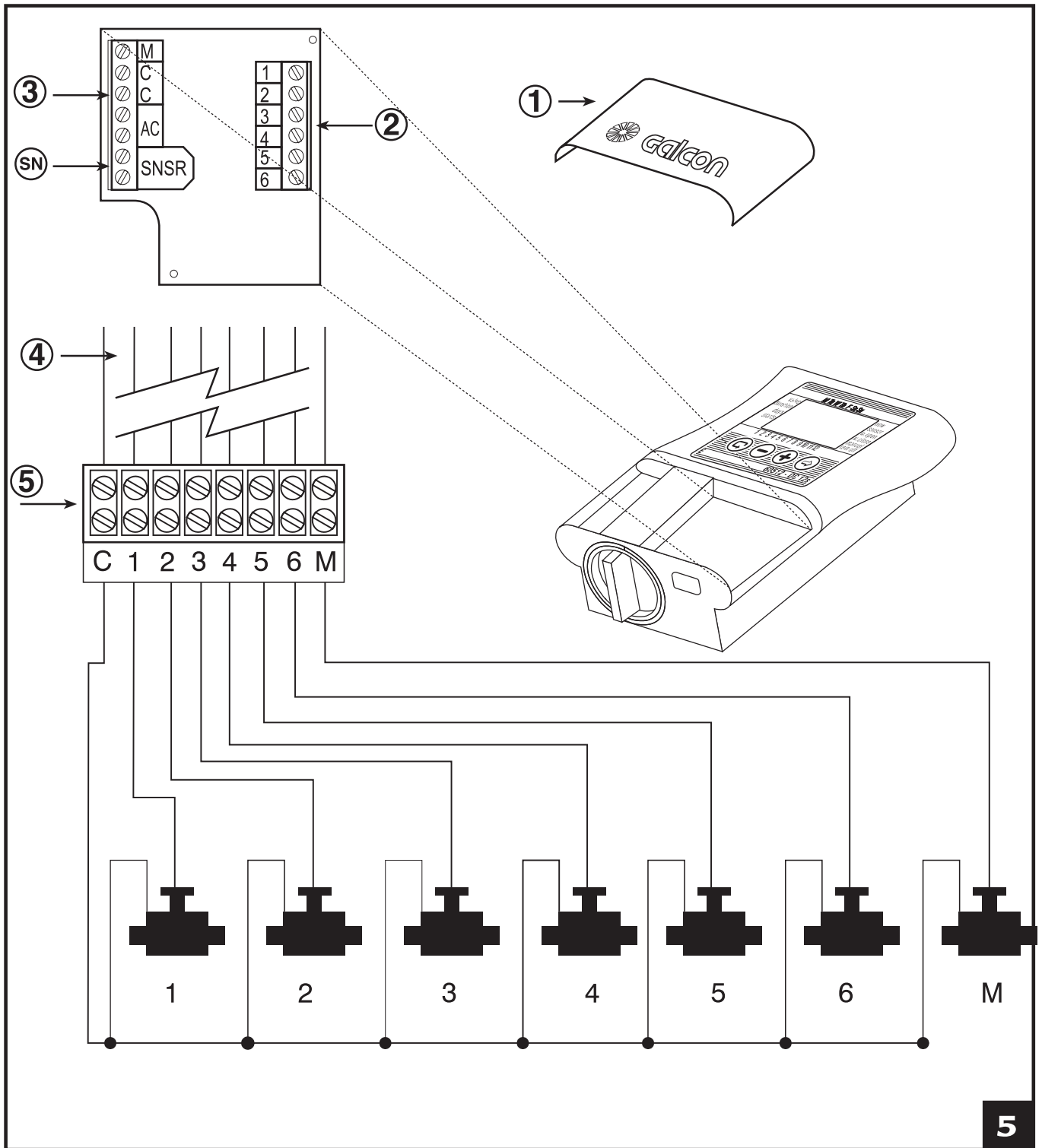

5

3. AC-9S-12S Installation and Connection Instructions

1. Open the controller housing hinged cover using the enclosed key (Figure 1).
2. To access the connection panel and the screw holes, open the controller panel by releasing the lock screws on the controller's left side, under the main cover (Figure 1).
3. Mount the controller to the wall or to the control closet by inserting the mounting screws through the indicated holes (Figure 2). Cover the crews with the 3 supplied caps.
4. Selector: one valve or two
Operation of a single valve, or two simultaneously.
Determine the type of operation by setting the selector switch to the desired mode.
V1 setting- single valve.
V2 setting - two valves simultaneously. (See Figure 8).
5. Connecting the battery:
Connect a 9V Alkaline battery in the place designated for it (Figure 2).

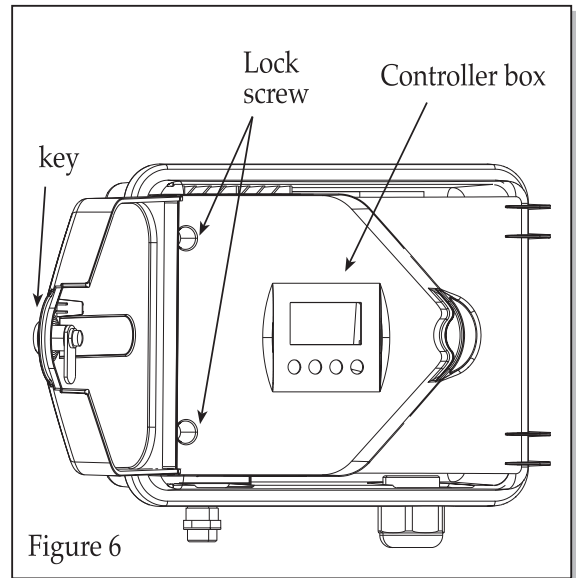

Figure 6

Important: Do not change the selector setting after the battery is connected.

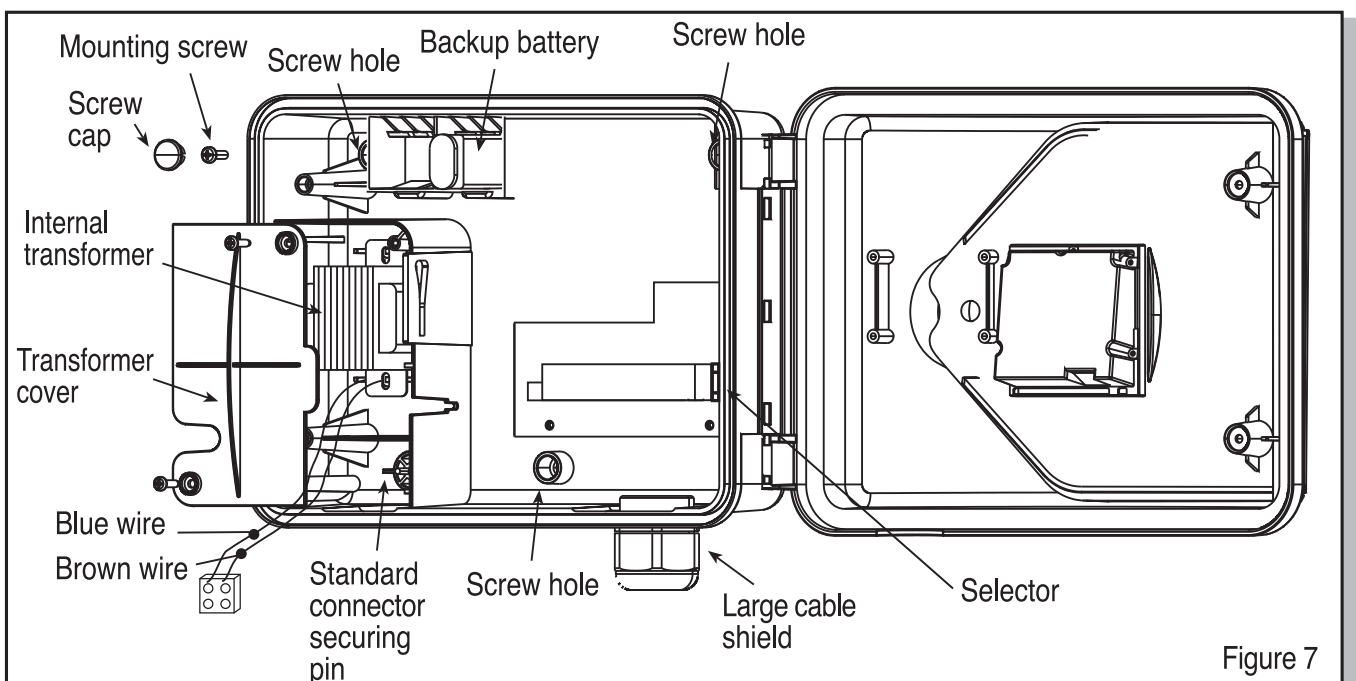

Figure 7

About the Transmission cable (see subparagraph 2.3 on page 5)

Connecting the Solenoid Wires to the AC Voltage Source and to the Sensor

Connect the valves to the controller before connecting the controller to the mains supply. See Figure 9.

Use only the transformer supplied, or a CE certified transformer with a 230VAC, 50Hz input, and 24VAC, 830mA output. In addition, it must be a SELV transformer, and IEC 61558 or VDEO 700 compliant.

Connection of the irrigation controller to electrical devices other than the irrigation valves and the transformer must be performed by a qualified electrician only.

General(figure 5)

Each solenoid has two wires of identical color and polarity extending from it. One of the wires (it does not matter which) connects to the matching valve number on the right connection block on the controller (2). The second wire connects to a common point "C" on the top and bottom connection blocks (3). The distance between the controller and the valves is usually longer than the length of the solenoid's wires, and therefore, a "transmission cable" is usually used to connect between them (4). The solenoid wires connect up to a connection box (5) installed near the valves. A transmission cable connects the box to the controller.

The connection box and transmission cable are not supplied with the product.

Connecting the Solenoid Wires to the Connection Box (figure 5)

1. Mark the connection points on the connection box (5): 1, 2, 3, 4, 5, 6, M and C. We recommend marking all points, even if there are more points than actual valves to be connected..
2. Connect one wire from each solenoid to a separate point in the connection box (5). Ensure that the number of the actual valve matches the number marked in the box: valve 1 to point 1, Valve 2 to point 2, etc. The master valve (if any) connects to point marked "M" in the box.
3. Connect the remaining wire from each solenoid to the point marked "C" in the connection box.

Connecting the Transmission cable

1. To access the connection panel, open the controller panel by releasing the lock screw at the right. See Figure 7.
2. Connect the wires from the transmission cable to the connection points on the bottom and top connection blocks: to points 1-6 on the bottom connection block and to points 7-12 on the top connection block. See Figure 9.
Both connection blocks have a "C" connection point. Draw yourself a diagram of the connection point numbers and the colors of the wires that connect to them.
3. Connect the leads at the other end of the transmission cable (4) to the connection box (5) located near the valves, according to the color map and numbers prepared in the previous step.

Connecting the Controller to the AC Voltage Source

1. If an external transformer is used the wire must be tightened using the nylon cable band at the bottom of the printing circuit. connect the two transformer wires to the bottom connection block, at the points marked 24AC. The polarity does not matter. The transformer and electrical outlet to which it connects will be in a location protected against water, in accordance with the applicable safety requirements.
2. If an internal transformer is used, the minimum cable diameter allowed is 0.7 mm. Use a standard test appliance to verify that mains electricity is off. Thread the electrical cables through the small cable protector. Connect the three color-coded external wires (brown, blue and yellow) to the mains.
3. Note: a double pole switch must be connected between the electric current supply and the product. Important: Use of a ground (earth) with this product is mandatory. Connecting the internal power supply: The electrical mains outlet and the connection of the power supply will be made in accordance with the local regulations for "field electrical installations" by a qualified electrician in the possession of an appropriate license in accordance with the local standards and regulations and in accordance with the applicable safety requirements.
4. Sensor Connection (Optional) Connect the sensor wires to the point on the lower connection block marked SNSR (G). The polarity does not matter.
5. Note: Do not connect the controller to a power source that is shared by another electrical device.
6. If the controller is connected to a relay of any sort, the controller must be positioned at least 5m from the relay.

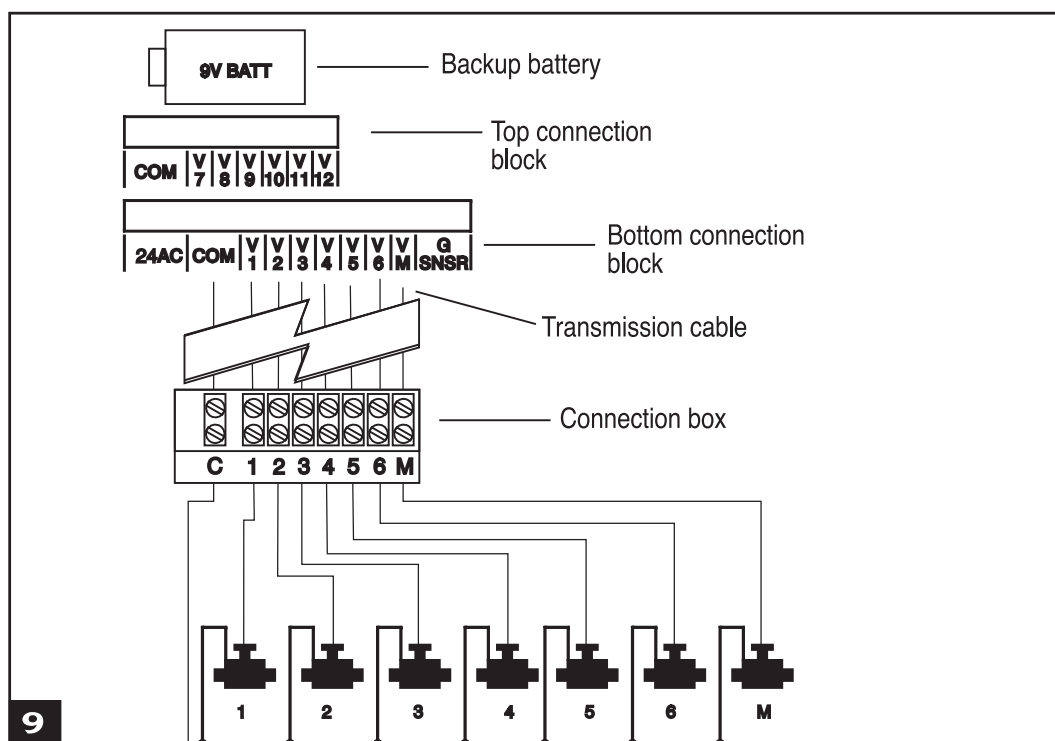

4. Programming the Irrigation Controller

This section describes the programming steps for a simple irrigation schedule. It is followed by a section of more advanced irrigation controller operations.

The irrigation controller is programmed with the aid of 4 buttons:

- ⌂ Programming Step Selector - used to select the desired programming mode (e.g., clock setting mode)
- ↔ Parameter Selection Button - used to select the parameter to be changed (e.g., hour, minute, etc.). Only when a parameter is blinking, can it be changed.
- ⊕ Increment Button - increases the value of the selected parameter (e.g., adds an hour).
- ⊖ Decrement Button - decreases the value of the selected parameter (e.g., subtracts an hour).

If you pause for 20 seconds while programming, the display automatically reverts to the clock display. You can continue the programming from that point.

4.1 Setting the Current Time and Day of the Week

To enable the irrigation controller to operate the irrigation system at the correct times, the current time and current day of the week must be set.



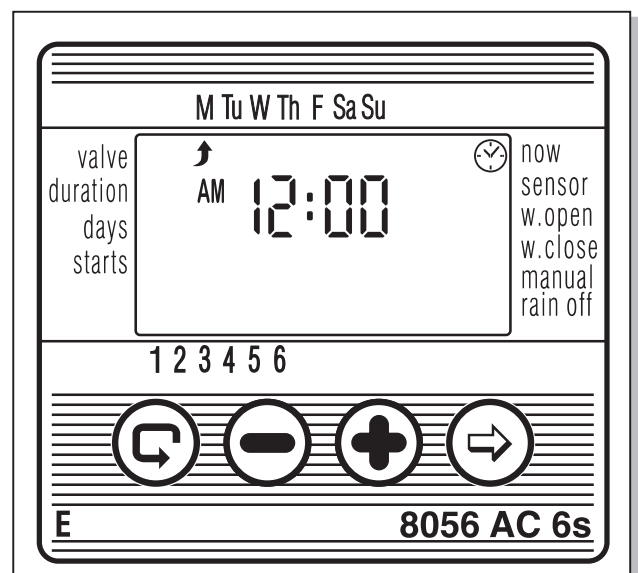

1. Press ⌂ several times until the ☺ appears.
2. Press ↔. The hour digits blink. Set the current hour using ⊕ and ⊖ (Note the AM and PM designations).
3. Press ↔. The minute digits blink. Set the current minute using ⊕ and ⊖.
4. Press ↔. A blinking up arrow appears at the top of the display. Move the arrow to the current day of the week using ⊕ or ⊖.

If the most recent data item stops blinking before you finish programming it, press ↔ to continue the programming process.



4.2 Switching between AM/PM and a 24 Hour Time Format

The default time format is AM/PM. You can choose a 24 hour time format if you prefer. To switch between the two formats:





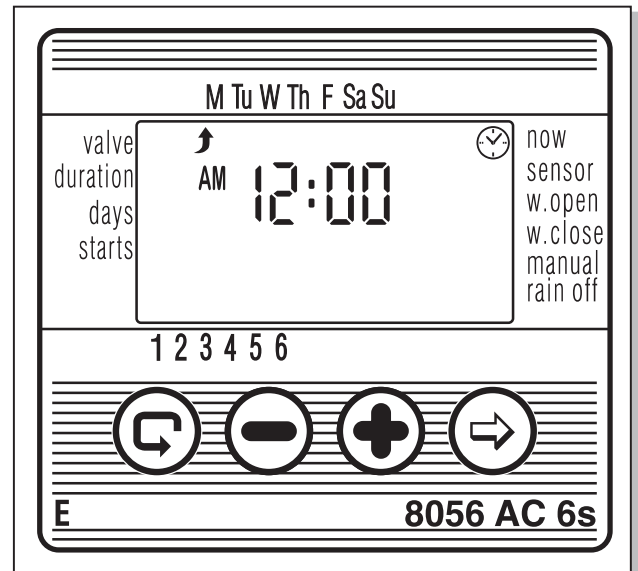

1. Press  until the  appears.
2. Press . The hour digits blink.
3. Press  and  simultaneously. The clock reading switches from AM/PM to a 24 hour time display (or vice versa).

You can switch the time display format at any step in the programming process.



4.3 Valve Selection





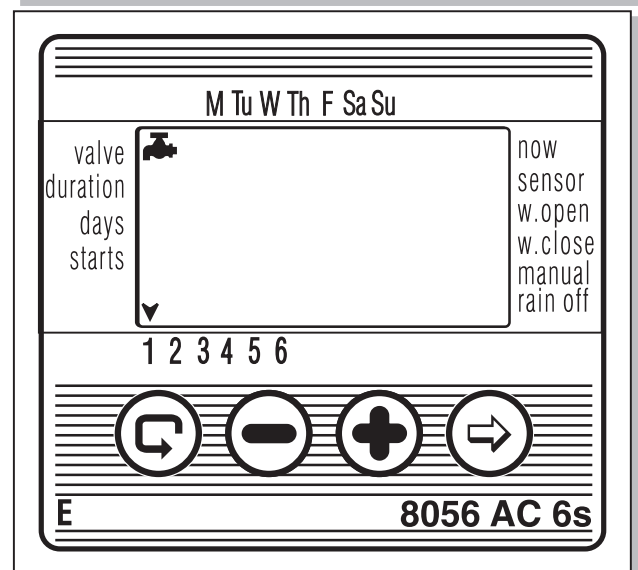



You program an irrigation schedule separately for each valve. First select the desired valve, and then program a schedule as follows:

1. Press  until  appears.
2. Press . A blinking arrow appears at the bottom of the display.
3. Move the arrow to the desired valve number by pressing  or .
4. Press  to proceed to the next step.



4.4 Setting the Irrigation Duration

This setting determines how long the irrigation lasts.





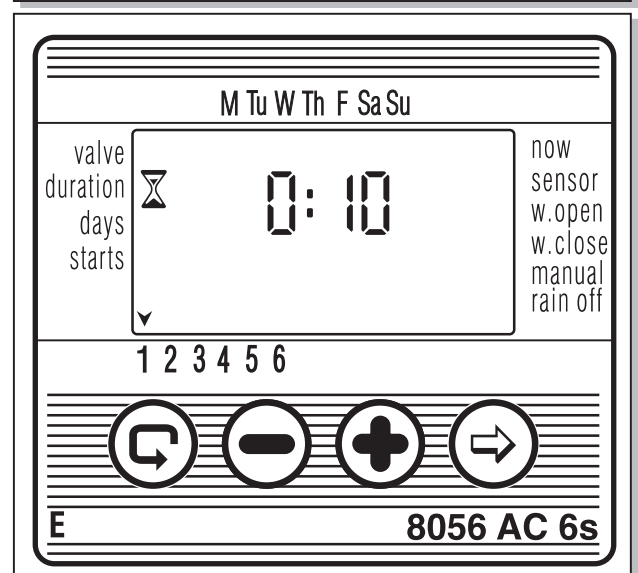

1. Press  until  appears.
2. Press . The hour digits blink. Set the desired number of hours by pressing  and . Press  again - the minute digits blink. Set the desired number of minutes by pressing  and .
3. Press  to proceed to the next step.
4. In professional controllers - the "S" series - the irrigation duration can also be programmed to an accuracy of seconds.





The method of programming is the same.



4.5 Selecting Days of the Week for Irrigation

This setting determines on which days of the week the irrigation controller will operate the specified valve.





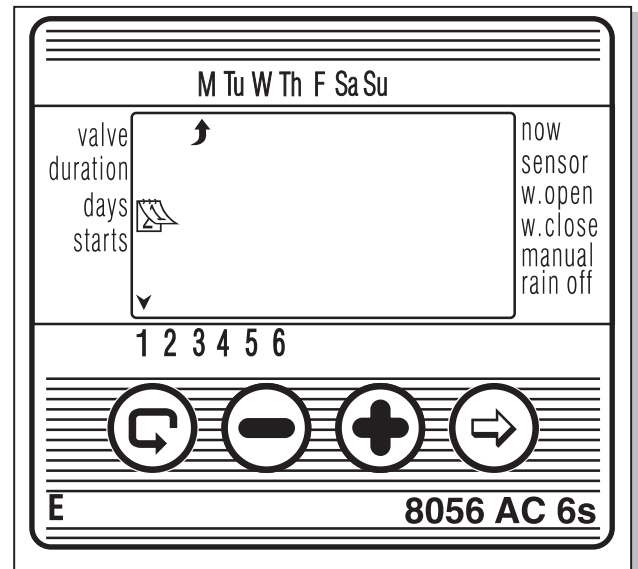





1. Press  until  appears.
2. Press . A blinking arrow appears at the top of the display, under Monday.
3. Move the blinking arrow to the desired day of the week by pressing .
4. Selecting/adding irrigation days:
Press . The arrow under the selected day stops blinking, moves one position to the right, and blinks under the next day of the week. You can select additional days of the week in the same manner.
5. Canceling Scheduled Irrigation Days: Have the arrow blink under the day you want to cancel. Press . The arrow under the selected day will disappear. The blinking arrow will move one position to the right, under the next day of the week. Cancel additional scheduled irrigation days in the same manner.
6. Press  to proceed to the next step.

* When the blinking arrow reaches Sunday, pressing  again displays  in the center of the display, and  at the top right of the display. To return to "Selecting/Adding Irrigation Days" mode, press  once or twice.



4.6 Setting Irrigation Start Times

In this step, up to 4 separate irrigation start times can be programmed for a selected day for the valve being programmed. The selected valve will open at each of the start times set, for the irrigation duration set as described in Section 4.4.



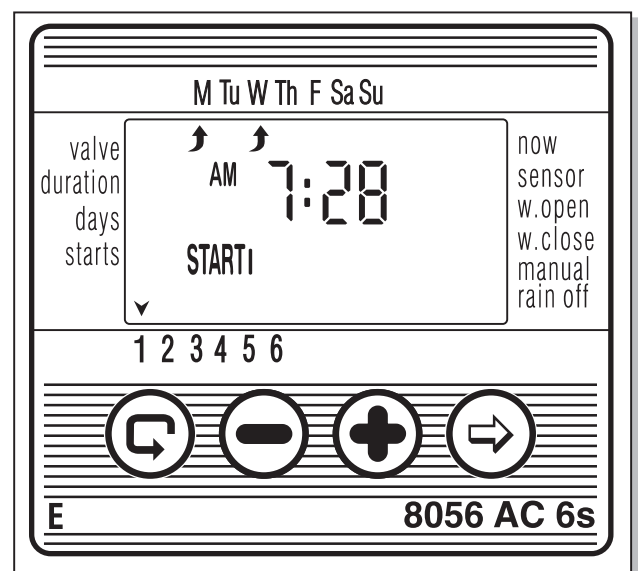



























1. Press  until START I appears. The word  FF or the last start time set appears on the display.
2. Press . The displayed item blinks (or the last start time entered).
3. Set the desired start time by pressing  and . (Take note of the AM and PM designations). Repeat actions 2 and 3 to set start times II, III and IV, as needed.
4. To cancel a specific start time, select it by pressing . Next, press . The hour digits blink. Press  or  until the word  FF appears on the display.
5. To program another valve, select it, and repeat the above steps, starting from Section 4.3 above.



4.7 Example: Programming a Weekly Irrigation Schedule

Let's assume you want to program the irrigation controller to water three times a day using the 24 hour time display format: at 08:00 AM, 13:00 PM and 19:00 PM, for 2 1/2 hours at a time, on Tuesday and Friday.

To switch to a 24 hour time display format, see Section 4.2.





1. Press  until  appears.
 2. Press . A blinking arrow appears at the bottom of the display.
 3. Press  or  to move the arrow to the number of valve to be programmed.
 4. Press  until  appears.
 5. Press . The hour digits blink. Press  or  until the hour displays 2.
Press . The minute digits blink. Press  or  until the minute displays 30.
 6. Press .  appears.
 7. Press . A blinking  appears at the top of the display, under Monday.
Press  until the blinking arrow appears under Tuesday, and then press . The arrow under Tuesday will stop blinking and advance one position to the right, to Wednesday. Press  twice to move the arrow to Friday, and then press .
 8. Press . START I time appears. Press . The hour digits blink.
 9. Set the start time to 08:00 by pressing  or .
- Repeat this step to set START II time to 13:00 and START III time to 19:00.
10. Press . START IV time appears. Press . The hour digits blink.
 11. Press  or  until  appears. START IV is canceled.

5. Additional Functions

5.1 One-Time Irrigation

This function is used to program the irrigation controller to operate the irrigation system **once only**, for a defined irrigation duration, at a set time.

(Duration set as described in Section 4.4).



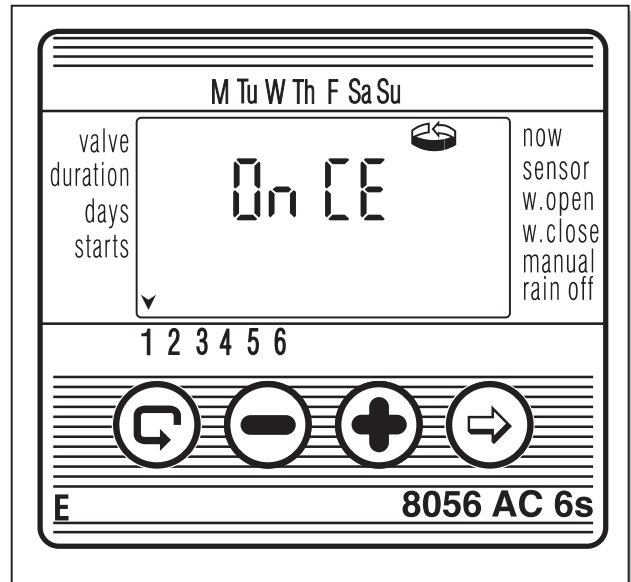



1. Press  until  appears.
2. Press  several times (for all the days of the week) until  appears, and  blinks display.
3. Go to Section 5.3 to set the day and start time.



5.2 Cyclical Irrigation

This option is used to program the irrigation controller to operate the irrigation system in a cyclical manner, once every x days, for the irrigation duration.

(Note: The duration for which each valve stays open is set as described in Section 4.4).

1. Press  until  appears.
2. Press  several times (for all the days of the week) until  appears, and  blinks on the display.
3. While the display is blinking, press  or . The interval between irrigation sessions (irrigation cycle) in days, hours or minutes is displayed. For example, if you set 2 days, theirrigation will be performed every two days for the defined duration.
4. In the "S" series of professional controllers, the irrigation cycle can be programmed from one minute up. The settings are performed in the same manner.

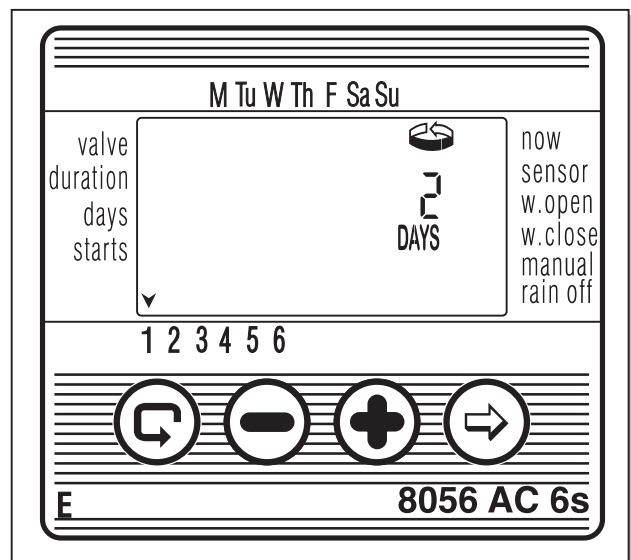

5.3 Setting the Day of the Week and Time for Cyclical and One-Time Irrigation Programs

These programs enable you to pre-set the valve start time (the time at which the valve opens). The number of days preceding the start time appears on the display, to the right of the start time (above the word "days").

0 days = Program starts today;
tomorrow, etc. (up to 30 days).

1. Press \odot until START I appears. The last start time entered is displayed.
2. Press \ominus . The hour digits blink.
3. Set the desired valve start time by pressing \oplus or \ominus (Take note of AM and PM designations).
4. Press \ominus until the digit to the right of the start time blinks (The digit above the word "days").
5. Set the number of days preceding the start time by pressing \oplus or \ominus .

*START II, III and IV are canceled in this mode.

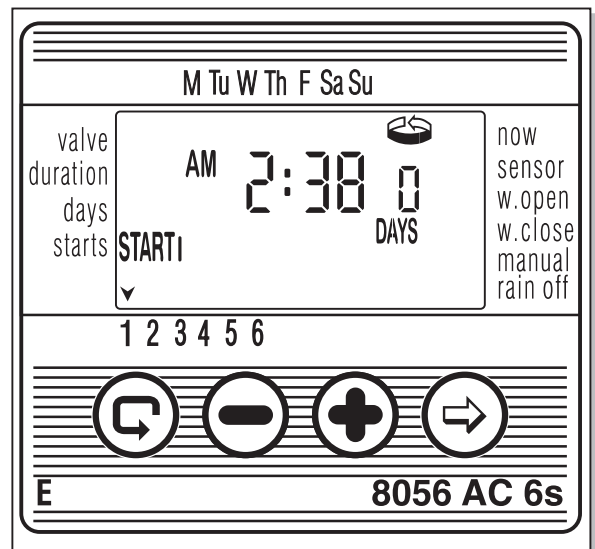







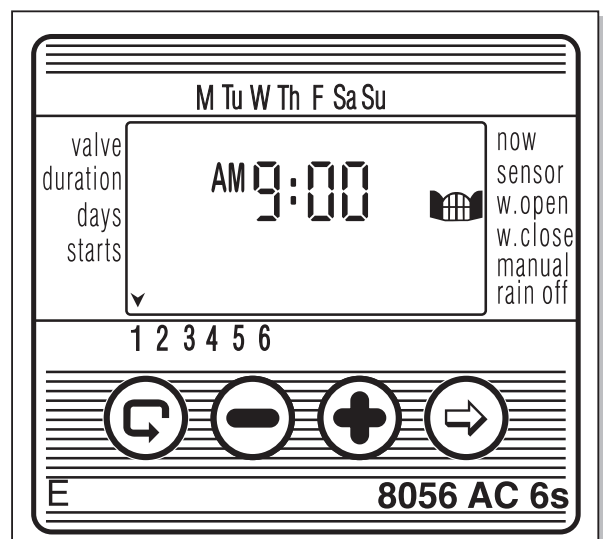

5.4 Irrigation Window In the Cyclical Program Mode

The irrigation window function is incorporated in the "S" series of professional controllers. It is an advanced feature allowing you to define that the irrigation in a cyclical program (see Section 5.2) be performed during a specific part of the day only (a window), such as the hot hours of the day. An irrigation window can only be defined for an irrigation cycle that is shorter than a full day (up to 23.59 hours), and only in the cyclical irrigation mode. If the defined irrigation cycle exceeds 24 hours, the window function is automatically disabled.

Example: 10 minute irrigation every hour in a window extending from 11:00 to 15:00.



1. Press  until  appears on the display next to W. OPEN. The word OFF or the last Window Open time setting is displayed.
2. Press . The word OFF blinks on the display.
3. Press  and  to set the desired Window Open time (pay attention to the AM/PM designation).
4. Press  until  appears next to W. CLOSE. The time 12:00 PM or the last Window Close time setting is displayed.
5. Press  and  to set the desired Window Close time (pay attention to the AM/ PM designation).

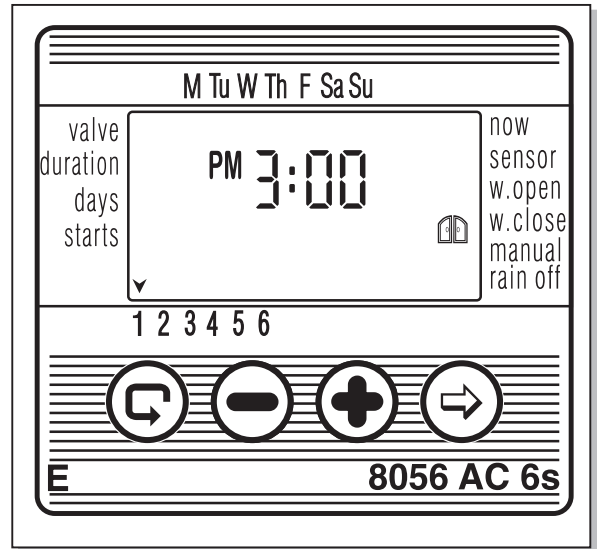

*If an irrigation cycle exceeding 24 hours is programmed, the irrigation window function is automatically disabled.

To cancel the irrigation window

appears next to W. OPEN. The last Window Open time setting is displayed.

2. Press . The irrigation Window Open time blinks on the display.

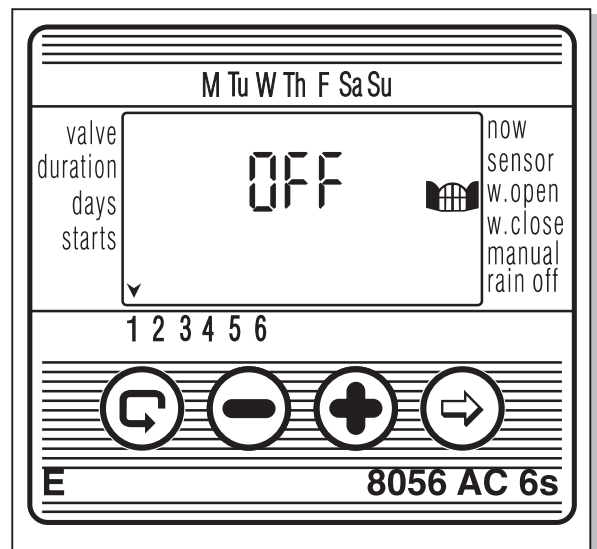

3. Press  until OFF appears next to .

The irrigation window is now cancelled.

















5.5 Opening an Irrigation Window after the Start Time has passed

Example: You are programming an irrigation schedule of 5 minutes of irrigation every 30 minutes, from 9:00 AM to 5:00 PM. However, you have entered the settings at 9:20 AM. As a result, the program will not commence today, but only from 9:00 AM tomorrow. To force the program to begin today, perform the following steps:

1. Press  until START I is displayed.
2. Press  and  to set any time after the current time: e.g. 9:30 AM. This time will constitute the first start time for today. From tomorrow, the schedule will operate according to your programmed settings. The Start I display shows the next start time in the schedule you programmed.

5.6 Example: Programming a Cyclical Irrigation Schedule









Let's assume you want to program the irrigation controller to open the valve once every 5 days at 12:45 PM for a period of one hour.

1. Set the irrigation duration as described in Section 4.4: Setting the Irrigation Duration. Press  until  appears. Press  and set the desired irrigation duration to 1 hour by pressing  and .
2. Press  until  appears.
3. Press  a number of times (for all the days of the week) until On CE is displayed blinking.
4. While the display is still blinking, press  or  until "5 days" is displayed, representing the irrigation frequency.
5. Press . START I is displayed.
6. Press . The hour digits blink.
7. Press  until the hour digits change to 12 (PM).
8. Press  until the minute digits change to 45.

5.7 "Manual" Irrigation System Operation via the Irrigation Controller

This function operates the selected valve now for the irrigation duration previously defined in the program. The valve will close automatically at the end of the irrigation duration.



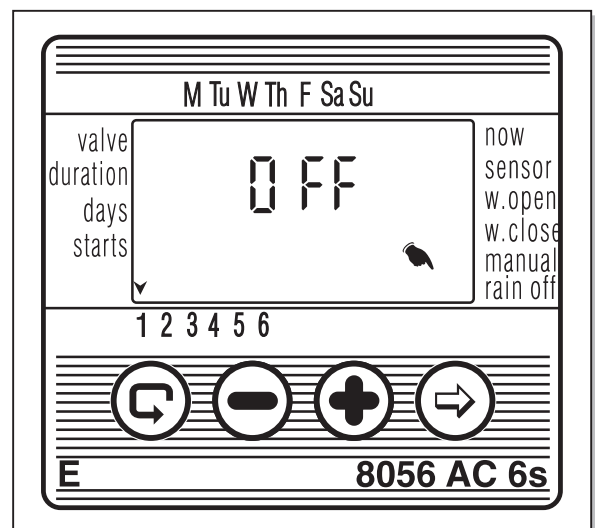
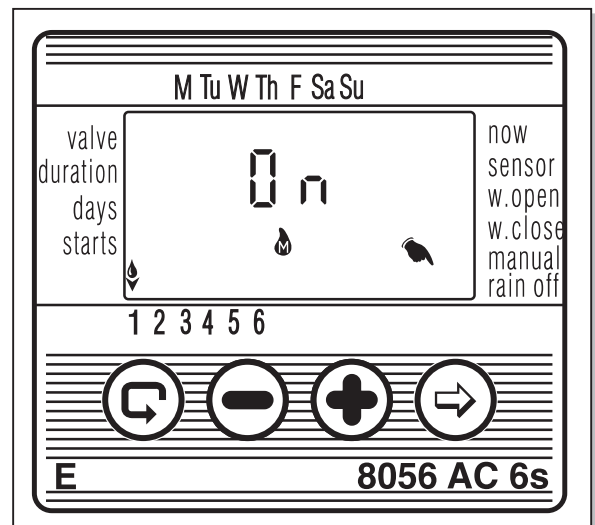

Note: the originally programmed irrigation schedule continues to operate at the set times.

1. Press  until  appears. Select a valve as described in Section 4.3: "Valve Selection".
 2. Press  until  appears.
 3. Press  to open the valve. The word "On" is displayed. After an interval of 5 seconds, a count down of the remaining irrigation duration appears on the display. This display lasts 20 seconds. To close the valve manually appears on the display.  FF during this period, press .
 4. To close the valve manually before the end of the irrigation duration after the display has reverted to the main clock, press  until ON appears again on the display. Press  to close the valve.
- Up to two valves can be operated simultaneously in this manner. Simply repeat the above steps for the second valve.



5.8 Sequential "Manual" Operation of all the Valves





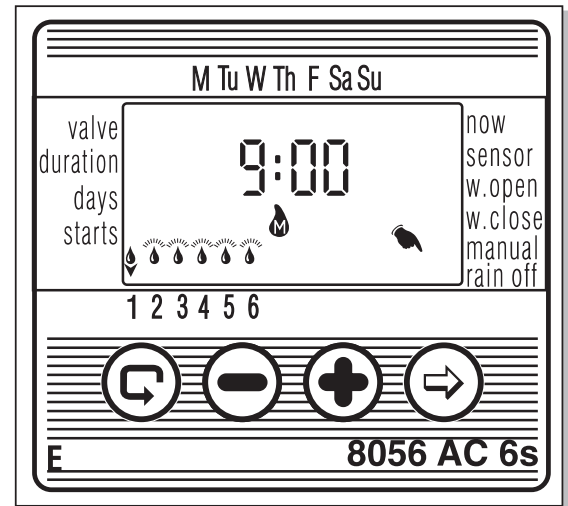



The valves can be operated sequentially, one after the other.

1. Press  until the  appears.
2. When nothing is blinking on the display, press and hold down  for 5 seconds. Valve 1 opens and operates for the programmed irrigation duration. When valve 1 closes, valve 2 opens, and so forth until the end. All the valves designated to open will blink.
3. You can intervene in the process. Pressing  closes the current valve and opens the next one.
4. Important: You can only exit this screen after all the valves have opened. In sequential operation, all the valves are on hold until the end of the sequence. They will therefore not open according to the scheduled program during the sequence.



5.9 Suspension

This option is used to temporarily suspend the irrigation controller's control over the valves, for example, while it is raining. The programmed irrigation schedule remains stored in the controller, but is not implemented. The suspension function disables all the valves, preventing any irrigation.



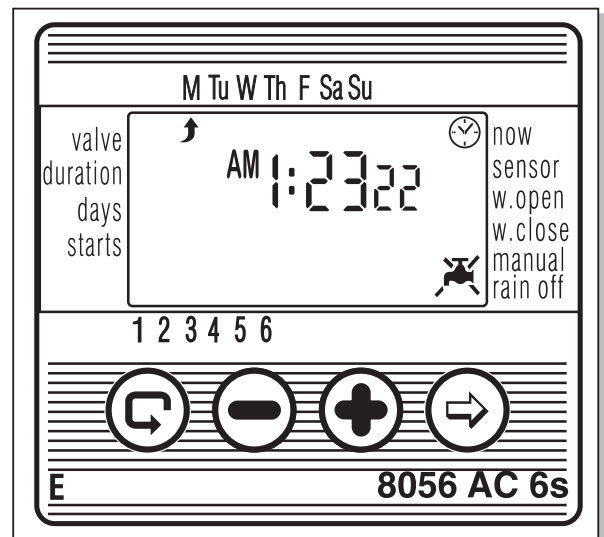





1. Press  until the  appears.
2. Press and hold down  for 5 seconds.  is displayed blinking alongside the word "rAinoff". The controller is now suspended.
3. To restore control to the controller, press  until the  appears, and then press and hold down  until the  disappears.
4. Suspension can also be implemented while a valve is operating.
5. If, by mistake, an attempt is made to operate a valve manually while the irrigation controller is suspended, or when a valve has been set to open sequentially, the word "rAin" appears on the display, and the valve will not open.



5.10 Irrigation Duration Extended or Shortened by a Specified Percentage

You can extend / shorten the irrigation duration for all the valves simultaneously by specifying a percentage for the duration.

Example: if the irrigation duration has been set to one hour, adding 10% extends the duration by 6 minutes (to 66 minutes).

1. Press  until the  appears.
2. Wait until none of the digits are blinking.
3. Press  and  simultaneously. 00+% is displayed.
4. Press . The 00 blinks. Press  or  to increase or decrease the percentage as necessary (in steps of 5%). +% or -% is permanently displayed on the main display , accordingly.

Important!

The percentage cannot be changed for an individual valve.

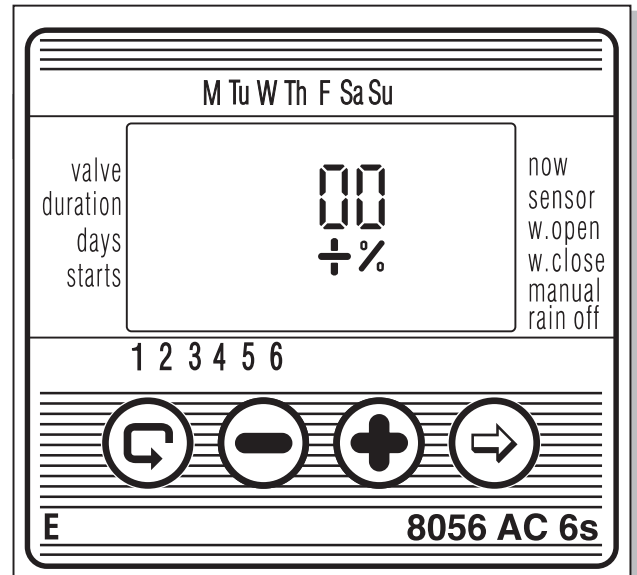

6. Additional Displays

6.1 Valve in Wait Mode

When two valves are currently open, and a third valve is scheduled to open, the third valve enters wait mode. A blinking  appears above the number of the waiting valve. When one of the first two valves closes, the waiting valve opens. During "manual" operation of a waiting valve via the irrigation controller, the letter "W" (Wait) appears on the display, and the valve will open the moment another valve closes.

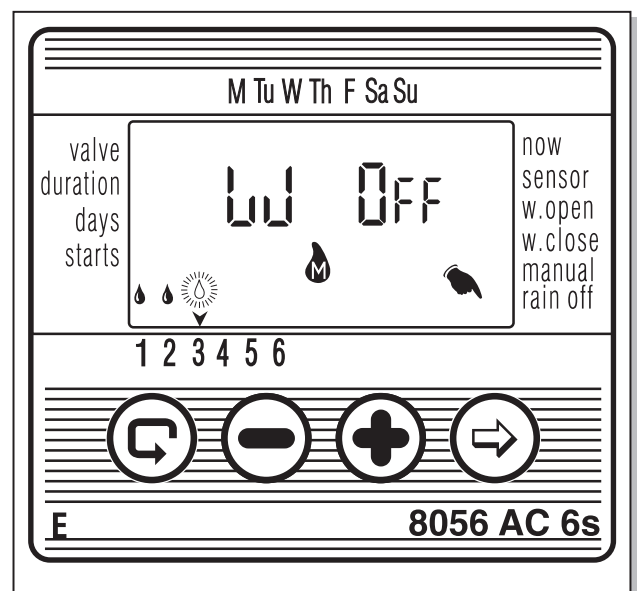

6.2 Blinking Low Battery Warning

When the battery is low, a blinking battery icon appears on the display. If the controller is not connected to the mains supply, the action of replacing the battery must be completed within 30 seconds to retain the programmed data.

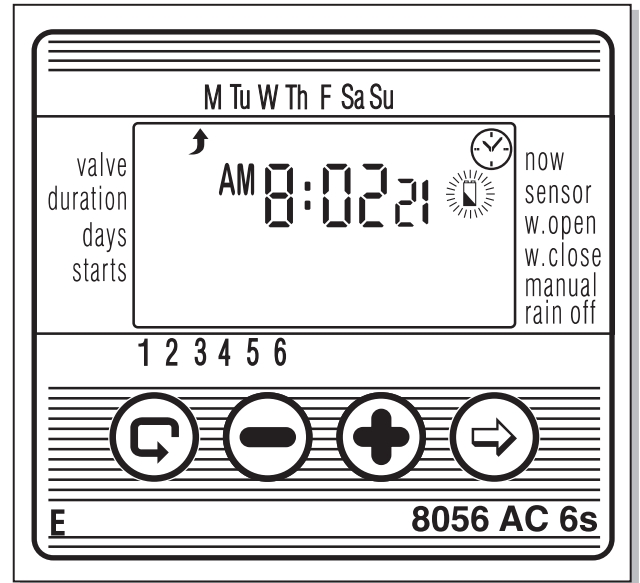

6.3 Missing Irrigation Program Data

If during "manual" irrigation system operation via the irrigation controller **no Prog** appears on the display. no irrigation duration has been set for the specified valve. That is, the controller "does not know" what the irrigation duration is. In this case, opening of the valve is disabled.

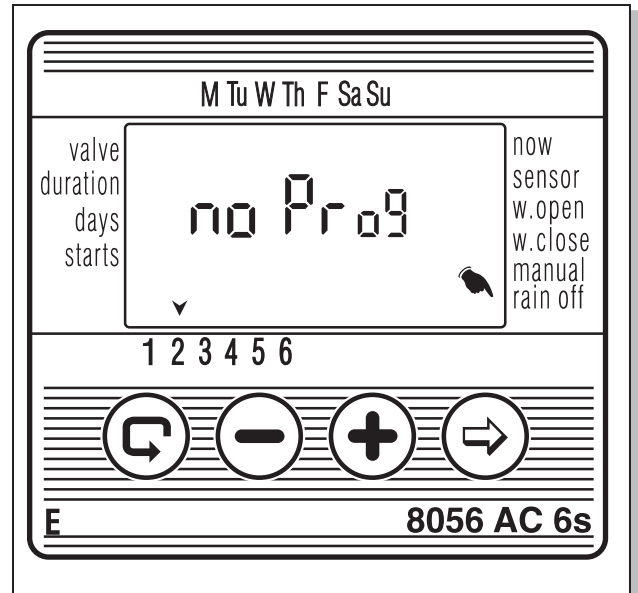

6.4 AC OFF - no AC Voltage Supply

If for any reason, the controller does not receive electricity, a blinking  is displayed, indicating that the controller is not connected to the mains. The display of the icon is powered by the backup battery. The message AC OFF appears on a manual display when the irrigation controller attempts to execute an irrigation program or "manual" irrigation program performed via it, but does not receive voltage supply from the electrical mains.

The controller can be programmed in this state (no AC voltage), but valves cannot be opened.

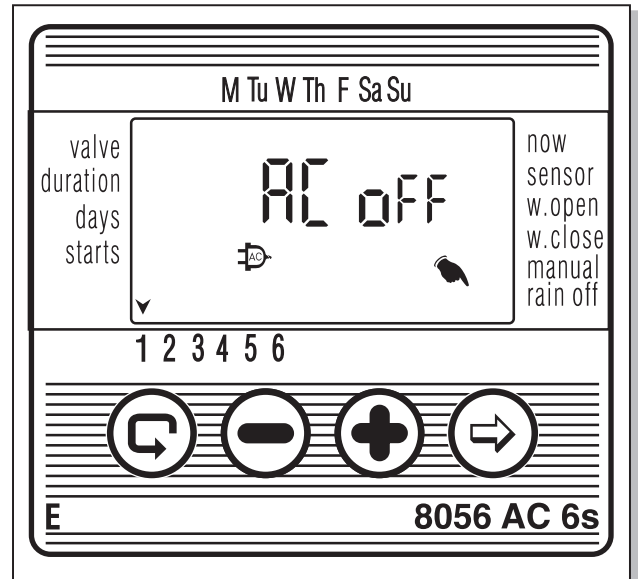



6.5 Valve Short Circuit

In the event of a short circuit in a valve or one of its connections, an  icon appears above the valve number and blinks every half a second (as distinguished from the Valve Wait mode described in Section 6.1).

To check if the valve is indeed shorted, select the blinking valve on a "manual" screen (see Section 5.7).

If the valve is shorted, the word **Short** is displayed.

6.6 Assigning a Valve to a Sensor

1. Select the valve you want to assign to a sensor.
2. Press  until  appears alongside the label SENSOR.
3. Press  to activate the sensor in the irrigation program for the selected valve. The word **On** is displayed.

- As long as the sensor closes the circuit (i.e., the sensor detects the existence of a defined program lockout condition) the symbol  blinks on the display and irrigation will not take place through the valve assigned to that sensor.

- Press  to disable sensor operation. The word **OFF** is displayed.

6.7 Irrigation Lockout Sensor

OFF appears on the display in the "manual" operation via the controller mode, signifying that the sensor is activated, and currently preventing irrigation.

In this state, the  icon blinks on the display. The irrigation program continues normally after the conditions invoking the sensor lock function are no longer valid.

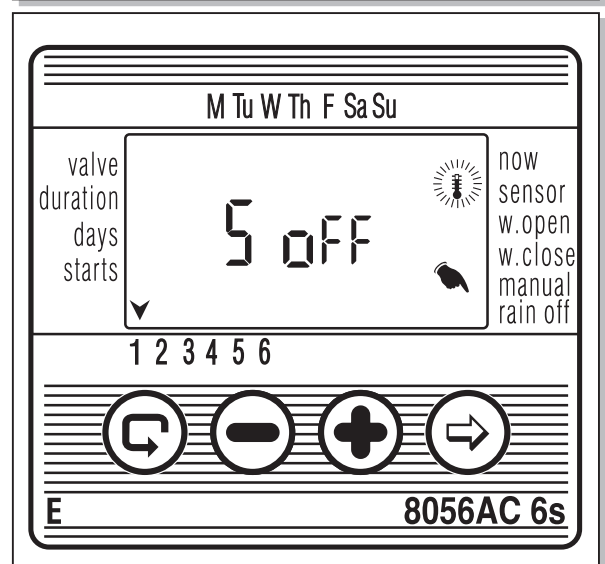
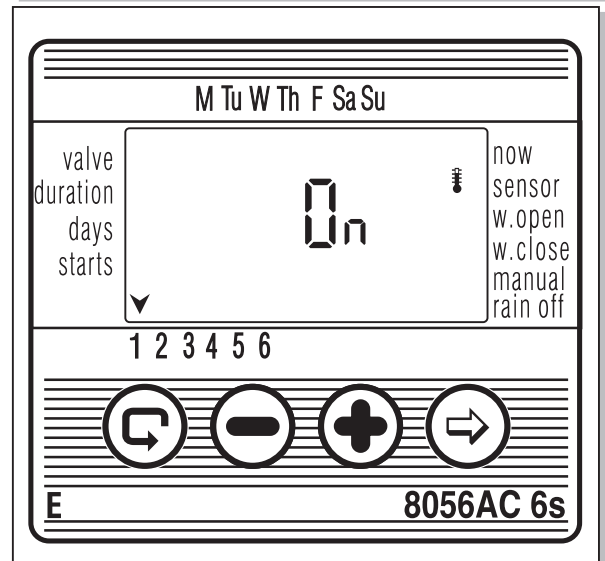
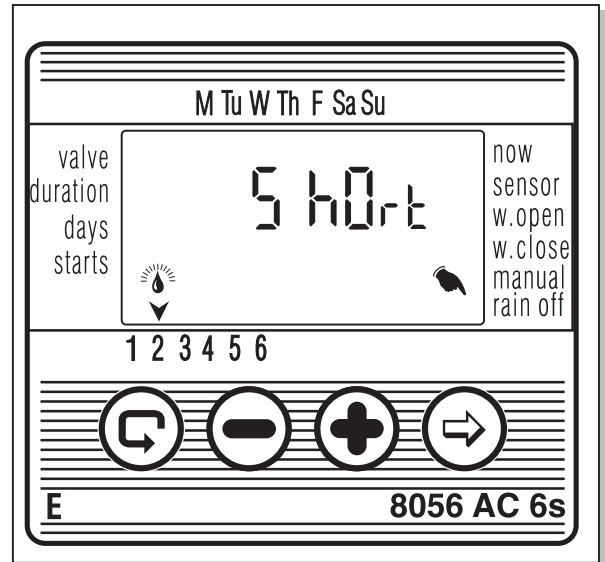

7. Maintenance

- A filter must be installed upstream of the controller valve and cleaned once every few months. Operation without a filter is liable to lead to malfunctions.
- Under normal usage, the battery (Alkaline) lasts at least a year.
- Recommended water pressure: 1-8 ATM (bar).

8. Troubleshooting and Repair

Problem/Event	Cause	Solution
Valve does not open during automatic operation or during "Manual" operation via irrigation controller		Move valve handle to AUTO position.
		Renew voltage supply, or replace the transformer
	Valve or connection shorted (see Section 6.5)	Replace master valve
	Master valve malfunction	
	The sensor prevents opening	
No display	Electrical mains malfunction, or defective battery.	Check voltage source/ transformer, or replace the battery.
Constantly blinking sensor icon, and valve does not open	Shorted sensor.	Replace sensor or repair the connection.
Valve does not close, despite click heard during activation	Valve handle not in AUTO position.	Move valve handle to AUTO position
	Dirt and scale in valve	Clean the valve
	Valve malfunction (such as a ruptured diaphragm)	Replace the valve
Faulty controller operation	Memory malfunction	<ol style="list-style-type: none"> 1. *Simultaneously press the 3 left buttons for 5 seconds, until the display disappears. 2. Release the buttons. All the controller displays appear briefly, followed by the time 12:00, blinking. The controller is ready to be programmed.

* Note: This action cancels all the programs set in the controller.

9. Additional Accessories

Lockable protective housing for the AC-4-6-6S Models

Line Filter, BSP 3/4"

Line Filter, BSP 1"

Spare Parts Kit

3/4" valve + solenoid, 24 VAC

1" valve + solenoid, 24 VAC

1 1/2" valve + solenoid, 24 VAC

2" valve + solenoid, 24 VAC

230/24 VAC transformer

2-wire transmission cable (100 m drum)

6-wire transmission cable (100 m drum)

8-wire transmission cable (100 m drum)

10-wire transmission cable (100 m drum)

Sensor

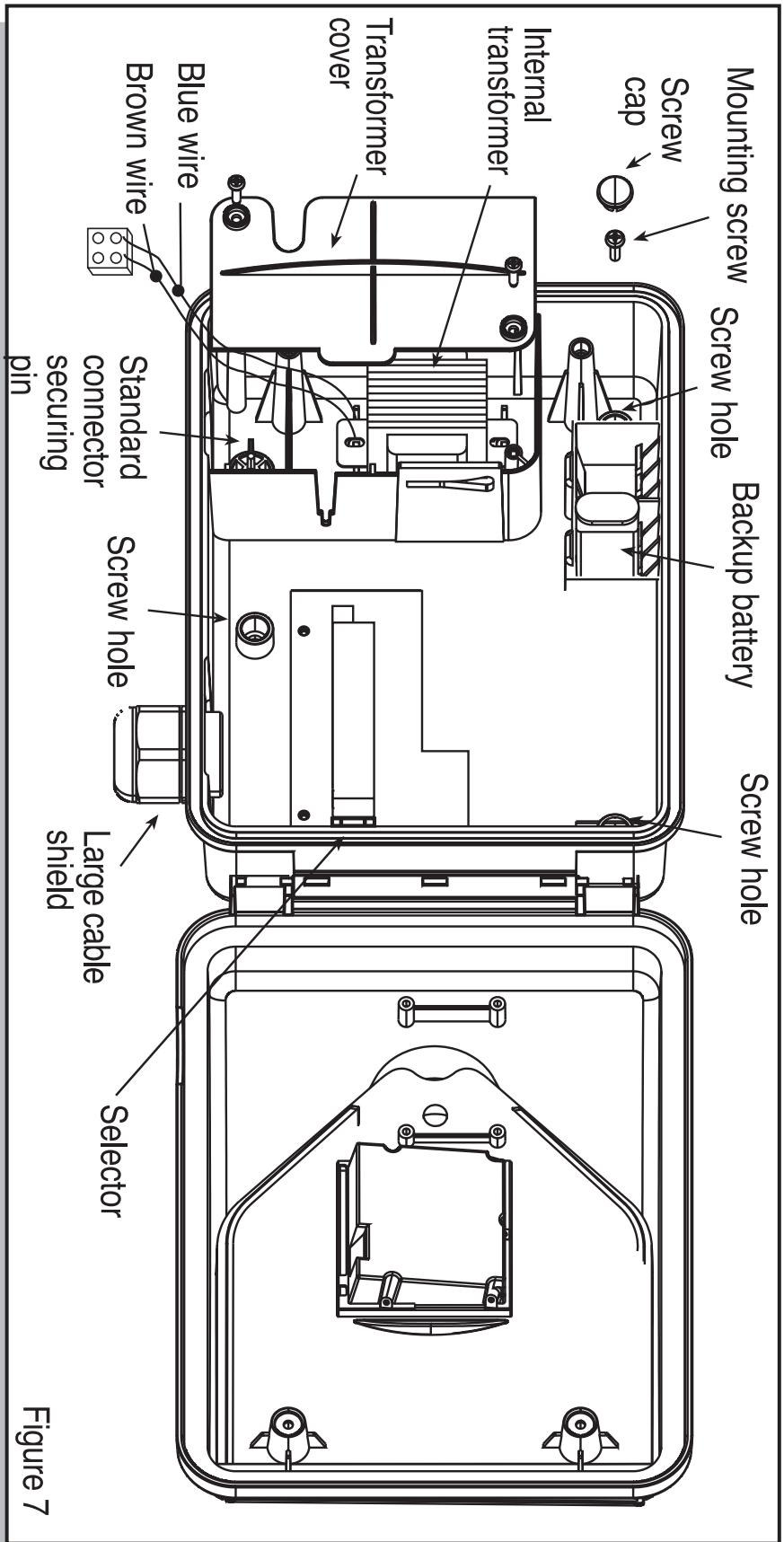

Figure 7



Planning the Irrigation Schedule with Galcon Controllers - Auxiliary Table

Date: _____

Valve No.	The irrigation/vegetation area (window box, porch [balcony], lawn)	Irrigation Program		Irrigation Duration (minutes, hours)	Daily start times			
		Weekly	Cyclical		1	2	3	4
1		M, Tu, W, Th, F, Sa, Su						
2		M, Tu, W, Th, F, Sa, Su						
3		M, Tu, W, Th, F, Sa, Su						
4		M, Tu, W, Th, F, Sa, Su						
5		M, Tu, W, Th, F, Sa, Su						
6		M, Tu, W, Th, F, Sa, Su						
7		M, Tu, W, Th, F, Sa, Su						
8		M, Tu, W, Th, F, Sa, Su						
9		M, Tu, W, Th, F, Sa, Su						
10		M, Tu, W, Th, F, Sa, Su						
11		M, Tu, W, Th, F, Sa, Su						
12		M, Tu, W, Th, F, Sa, Su						